



MILLSTORES CORPORATION

Infinite Possibilities.



About Us

Founded in the year 1965 by Mr. R.K Mantri, Millstores Corporation today has a glorious history of more than 50 years.

Today Millstores is among India's biggest Industrial distributor for Engineering Spares & Consumables with huge corporate client base pan India. Our Endeavour is to always understand the need of our clients and provide them quality products and services on time and every time.



Vision

To be a respected company in the field of industrial products, services and solution provider by delivering quality products & creating winning relationships.

Core Values



Customer First

Deliver quality products & services by adopting best practices



Valuing People

Create a culture that attracts and nurtures the best talent



Performance Focus

Ensure an environment that fosters teamwork & rewards performance



Nurturing Relationships

Cultivate mutually beneficial & Ethical relationships



From Chairman's Desk

"We aim to make a positive impact and Create Maximum Value for our Customers and to be their Strategic Partner for Industrial Products & Services."

R.K. Mantri - Founder

SKF Ball Bearing & Unit



Bearings



Plain Bearings



Pillow Block
(UC Series)



Plummer Block
& Accessories

SKF Lubrication Systems



Lubricants



Oil Container



Pump & Grease Gun



Belts, Chain, Coupling, Sprocket

Power Transmission

SKF Sealing Solution

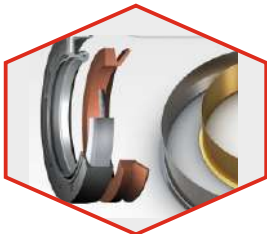

Oil Seal & Speedi Sleeve



Hydraulic Seals



Machine Seals



V-Rings & O-Rings

MaPro



Mounting Tools



Dismantling Tools



COMO



Alignment



SKF provides industry leading automotive and industrial engineered solutions through its five technology-centric platforms: bearings and units, seals, mechatronics, lubrication solutions and services.

SKF's solutions provide sustainable ways to achieve breakthroughs in friction reduction, energy efficiency, equipment longevity and reliability, with a strong commitment to research-based innovation.



SKF Hydraulic Seals

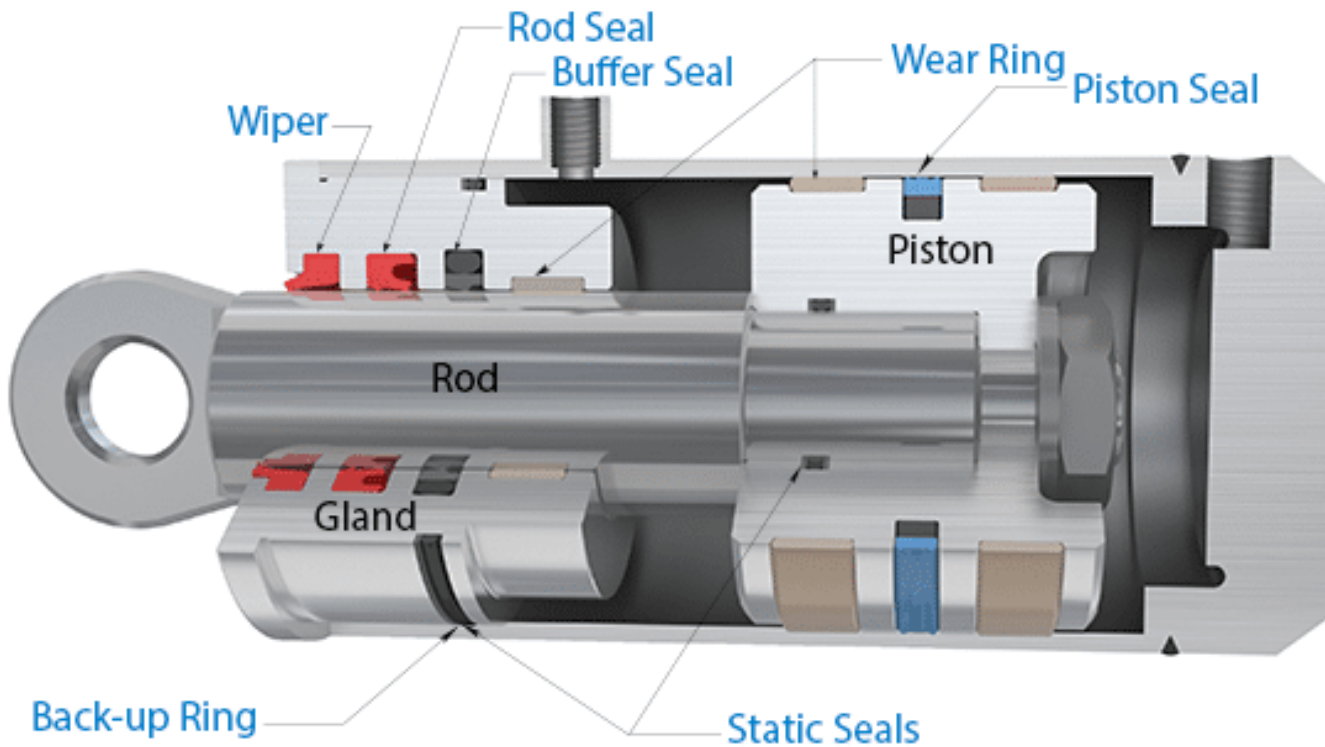

HYDRAULIC SEALS

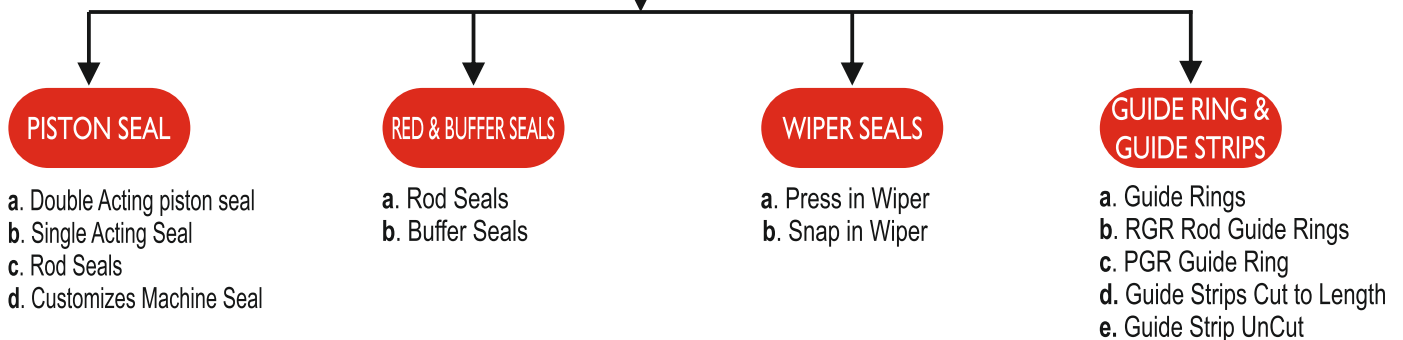

Hydraulic seals are used in cylinders to seal the openings between various components in cylinder. Seals are either moulded or machined and carefully designed using sophisticated simulation software. Products perform both dynamic and static sealing. The range includes piston, rod, buffer and wiper seals, as well as guide rings and O-ring.

Lubrication Solutions



Lincoln Centralize Lubricant System



Luberr Centralize Lubricant System



Multiple Application Single Solution

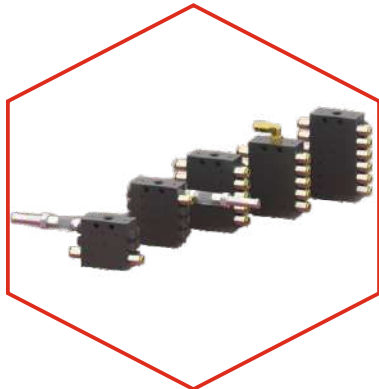

Pump Distributors



Capacitors



Manual Pump



Manual Operated Grease Pump



Pneumatics Operated Grease Pump



Hydraulic Operated Grease Pump



Industries focus on reducing the operating cost and improving productivity - we help our customers do both everyday.

Every application is different, we have a depth technical knowledge to understand the customer requirement and gives right solution for their optimal lubrication needs.

Save Grease, Save Downtime, Save Energy



General Ventilation & Molecular Filter

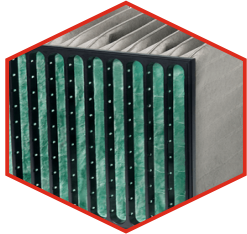

BAG



Box & Header Frame



Filter Bed

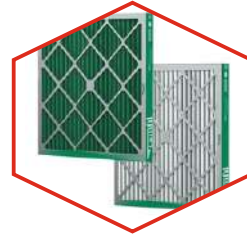

Panel

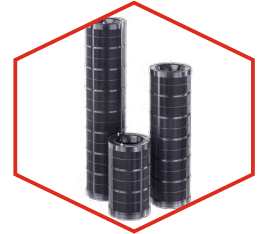

Cylinder Cam Carb

Housing, Frames and Louvers



Media Pads



Weather Louvers



Terminal Housing

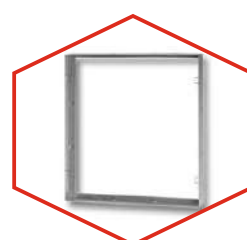

Holding Frame

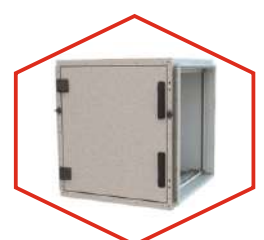

Ducted Housing

Turbo & Pulse Filter

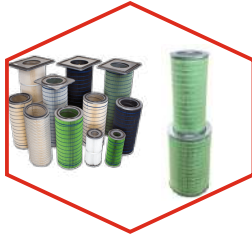

Cartridge

Air Cleaner & Purifier



Air Purifier & Cleaner

EPA, HEPA, ULPA Filters



Clean Room Panel



Compact Filter Box & Header Frame

Dust, Fume and Mist Collectors



The camfil group is a manufacturer of premium clean air solutions, They provide commercial and industrial systems for air filtration and air pollution control that improve worker and equipment productivity, minimise energy use and benefit human health and the environment. Camfil aim to conserve more, use less and find better ways so we can all breathe easier. Whatever your clean air challenge, camfil offers a dedicated filtration solution for your unique needs.

Mechanical Belt Fastning System



Bolt Solid Plate & Hinged Fastner

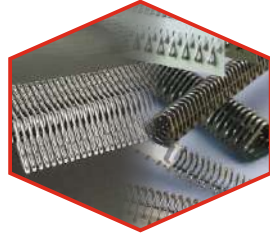

Staple & Cliper Fastner

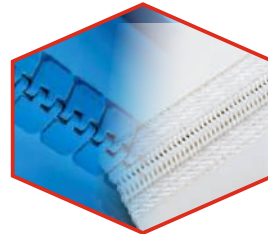

Alligator Plastic Rivet & Spiral Lace

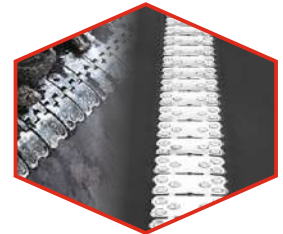

Rivet Solid & Hinged Plate

Belt Maintenance Tools



Belt Clamp



Belt Cutter



Flex Lifter



Belt Cutter Glam

Splicing Tools



Aero Splice Press



Mobile Finger Pinch



Ply Seperator

Impact Bed & Skirting System



Belt Accesories



Segmented Transfer Plate



Hitch Guard

Tracking Solution



Positioner & Trainer

Cleaning System

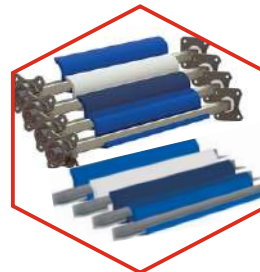

Pre & Secondary Cleaner









Belt Pows



As an industry leader since 1907, **FLEXCO** understand that your conveyors play a critical role in your operation's productivity. That's why **Flexco focuses on what you really need to make your belt conveyor as reliable as possible.** Their products help you take better care of your system and correct potential problems before they become serious issues.

If you have a special application or challenge, **FLEXCO** work with you to find a solution with and get the best possible performance from your belt conveyor system.



<p>WD-40 Multi-Use Product WD-40 Industrial Maintenance Application</p>	
<p>Fevitite Super Strong – Epoxy Adhesive Fevitite Rapid & Clear – Epoxy Adhesive</p>	
<p>Rustolene Electrical & Electronic Contact Cleaner Rustolene Rust Disintegrator</p>	
<p>Holdtite PTFE Thread Seal Tape Holdtite Perfect Liquid Sealant</p>	
<p>Steelgrip PVC Electrical Insulation Tape</p>	
<p>M-Seal Silicon Sealant – Acetoxy Cure M-Seal General Purpose/Phataphat – Epoxy Compound</p>	
<p>Fevikwik 203 / GP – One Drop Instant Adhesive Fevikwik Gel – One Drop Instant Adhesive</p>	



Pidilite focus is on innovating specialty products that cater to the manufacturing sector. **Industrial adhesives, synthetic resins, organic pigments, pigment preparations and surfactants are part of this business.**

Despite the emergence of products similar to their brands, They continue to remain the market leader in the adhesive industry and their brands continue to win market share and hearts.



Blowers



Rotary Screw Compressor



Reciprocating Compressor



Portable Compressor



Controller



Air Treatment &
Condensate Technology



Compressed Air
Storage Distribution



Sigma Air Utility



Used Equipment



KAESER COMPRESSOR is one of the world's leading manufacturers and providers of compressed air products and services.

KAESER products stand out for their remarkable reliability, energy efficiency, cost efficiency and ease of maintenance all of which help the company to achieve its top priority : complete customer satisfaction



Pneumatics System



PU Tube



Fittings



Cylinder



Sensor



Vaccum Cups

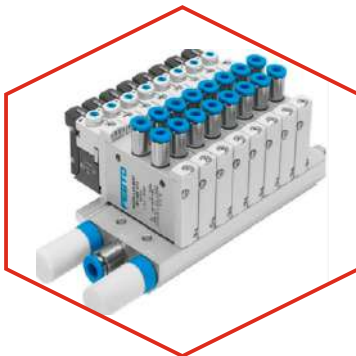

Valve

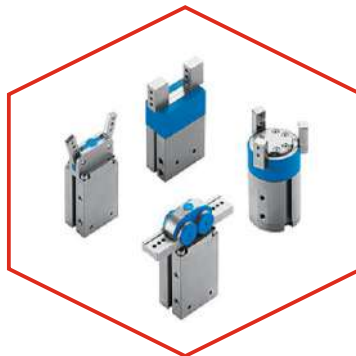

Handling System

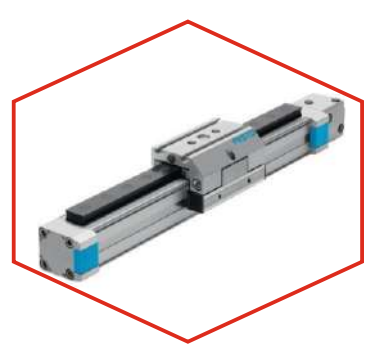

Drive & Actuator



Motor & Controller



Vision Mission

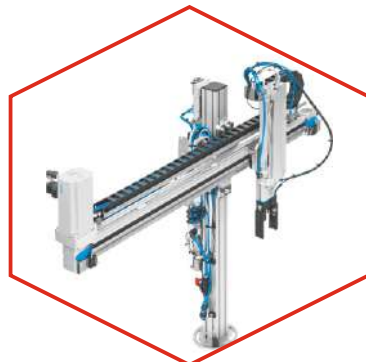

Handling System



The right solution for all requirements: **FESTO** offers products, systems and services for pneumatic and electrical control and drive technology for factory and process automation. Whether electric, pneumatic or a clever combination of both **FESTO** offers **cross technology solutions** without any technical restriction, from motion control to electromechanical component.

Measuring Tools



Vernier Calliper



Micro Meter



Inside Measuring Tool



Microscope



Dial Indicator



Height Measuring Tool



Depth Measuring Tool



Roundness Tester



Surface Roughness Tester



Calibration Equipment



Repair & Calibration



Mitutoyo is in tune with the needs of the manufacturing industry in the fastest growing economies of the world. It is committed to bring the latest technology in dimensional metrology with world class service to every customers



PU Sole Series

Economy PU Sole



SA21000SD



SA11000SD



SA4000DD



SA2000DD



SA7000SD
(ELECTRICAL)



SA7000DD

Heat Resistance Sole



SA3000
(NITRILE PU)



SA4000
(NITRILE)



SA10000
(NITRILE PU)



SA9000SD



SA22000SD



SA23000SD

PVC Sole

Premium PU Sole



SA19000SD



SA12000DD



SA7000DD



SA1000SD

Ladies PU Sole



SA17000SD



SA19000SD

SD - Single Density, DD - Double Density



It is endeavour in **SUPER ANCHOR** to provide only the finest and the best solution in the field of personal protection to our valued customers.

SUPER ANCHOR specializes in the field of Foot Protection. They manufacture the highest quality equipment conforming to IS & EN norms, leading the way with new innovative products and solutions with every passing year.

Respiratory Protection



Filtering Facepiece Respirators



Half Face Mask



Full Face Mask



Supply Air Respirator Unit



Powered Air Purifying Respirator



Self Content Breathing Apparatus



Emergency Life Saving Apparatus



Escape Hood

Eye Protection



Safety Goggles



Welding Goggles



Eye & Face Protection



Industrial Safety Helmet

Head & Face Protection

Sorbents



Sorbents

Hearing Protection



Ear Muffs



Reuseable Earplugs & Earband

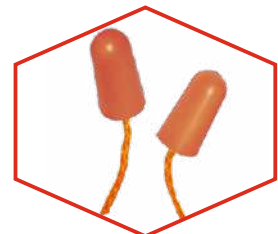

Disposable Earplugs & Dispenser



VENUS Safety & Health Pvt. Ltd. is a global quality manufacturer of Neck-up Personal Protective Equipment's (PPE) inception in year 1986.

Certified in accordance with ISO 9001:2015 and are audited annually by BUREAU VERITAS.

American Stand. : 42 CFR part 84 European Stand. : EN 149/140/143/14387

Indian Stand.:IS 9473/14746/14166/15323/10245(II&III)/2925/9167/5983/15322/16289



Linear Motion Solution Products



7th Axis for Robot

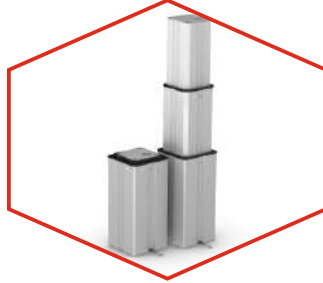

Lifting Column

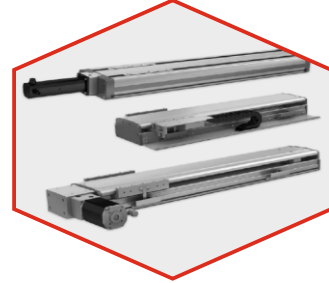

Linear System



Linear Actuators



Linear Guides

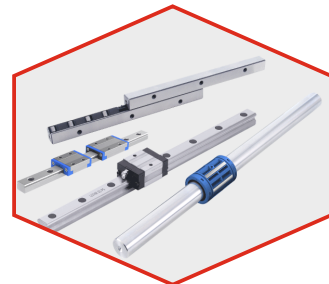

Ball & Roller Screw

SKF Services



Vibration Analysis



Dynamic Balancing



Shaft &
Pulley Alignment



Thermography



Bearing
Remanufacturing



Training



Ewellix is the leading global manufacturer and supplier of linear motion solutions, which incorporate state-of-the-art designs, components and digital technology. **Ewellix design, manufacture, customise linear motion and linear actuators including smart actuators, guides and ball and roller screws for a variety of industrial applications that help customers shift to electrified solutions.**



MILLSTORES CORPORATION
Infinite Possibilities..



Panvel

Plot No. 22A, 22B, 1 st Floor
Panvel Ind. Estate, Behind
Simran Motor, Panvel-410206
Maharashtra.

☎ 84229 55996

✉ info@millstorescorporation.com

Mumbai

158/160, Narayan Dhruv Street
2nd Floor, Mumbai-400003
Maharashtra.

☎ 022-49739517

✉ info@millstorescorporation.com

Bharuch

Shop No. 1,2,3, Sai Heights
College Road, Opp. Hotel Ashish
Bharuch - 392 015, Gujrat

☎ 96017 96623

✉ sales@millstorescorporation.com

Nagpur

Shop No. 1, Chawla Complex,
Near Gurudwara, Amrawati Road
Wadi, Nagpur-440023, Maharashtra.

☎ 90999 70208

✉ yash@millstorescorporation.com



**MILLSTORES
CORPORATION**
Infinite Possibilities..